

# Yoast Candy Co Inc

51 S Cochran St, 44618 Dalton, OH, United States

TOTAL AREA: 24366.23 sq ft • LIVING AREA: 24085.83 sq ft • FLOORS: 1 • ROOMS: 22



## ▼ Ground Floor

TOTAL AREA: 24366.23 sq ft • LIVING AREA: 24085.83 sq ft • ROOMS: 22



THIS FLOOR PLAN IS PROVIDED WITHOUT WARRANTY OF ANY KIND. SENSOPIA DISCLAIMS ANY WARRANTY INCLUDING, WITHOUT LIMITATION, SATISFACTORY QUALITY OR ACCURACY OF DIMENSIONS.

0' 16' 32' 48'

# Yoast Candy Co Inc

51 S Cochran St, 44618 Dalton, OH, United States

TOTAL AREA: 24366.23 sq ft • LIVING AREA: 24085.83 sq ft • FLOORS: 1 • ROOMS: 22



## ▼ Other Ground Floor

WIDTH: 80' 2 3/4" • LENGTH: 107' 10" • CEILING HEIGHT: 25' 2"  
AREA: 7003.77 sq ft • PERIMETER: 375' 11 1/2"

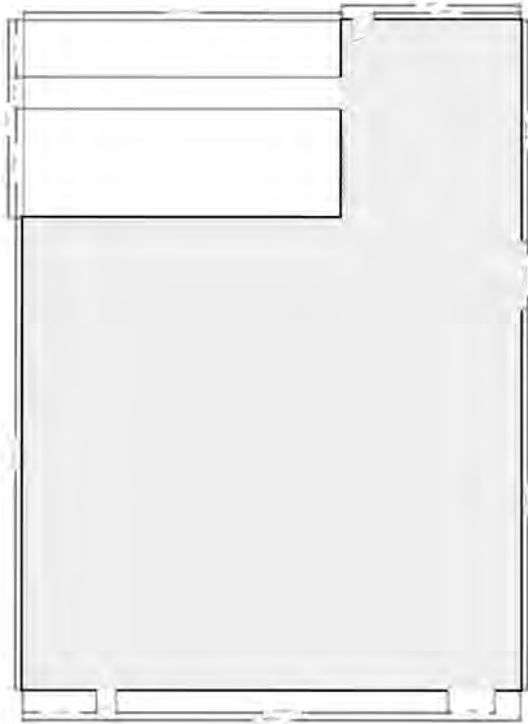

## ▼ Other Ground Floor

WIDTH: 71' 5 1/4" • LENGTH: 39' 10 1/4" • CEILING HEIGHT: 13' 1/2"  
AREA: 1934.40 sq ft • PERIMETER: 222' 6 3/4"

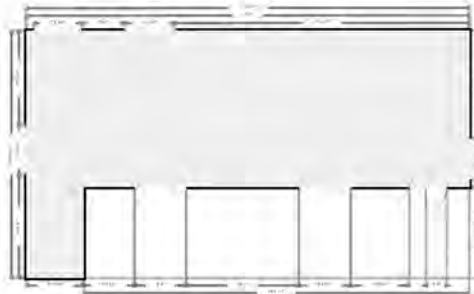

# Yoast Candy Co Inc

51 S Cochran St, 44618 Dalton, OH, United States

TOTAL AREA: 24366.23 sq ft • LIVING AREA: 24085.83 sq ft • FLOORS: 1 • ROOMS: 22



## ▼ Other Ground Floor

WIDTH: 53' 10 1/2" • LENGTH: 79' 4 1/4" • CEILING HEIGHT: 12' 2 3/4"  
AREA: 3709.82 sq ft • PERIMETER: 266' 4 3/4"

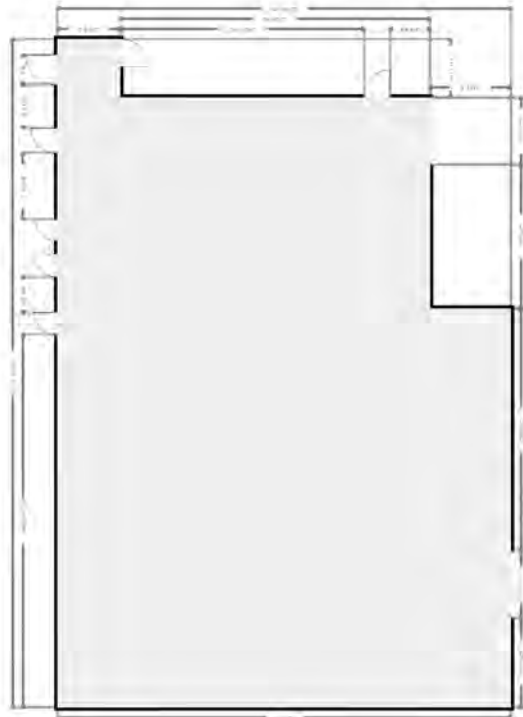

## ▼ Other Ground Floor

WIDTH: 26' 1 1/2" • LENGTH: 14' 9 3/4" • CEILING HEIGHT: 12' 5"  
AREA: 387.03 sq ft • PERIMETER: 81' 10 3/4"



# Yoast Candy Co Inc

51 S Cochran St, 44618 Dalton, OH, United States

TOTAL AREA: 24366.23 sq ft • LIVING AREA: 24085.83 sq ft • FLOORS: 1 • ROOMS: 22



## ▼ Other Ground Floor

WIDTH: 17' 8 3/4" • LENGTH: 14' 10" • CEILING HEIGHT: 12' 7 3/4"  
AREA: 208.33 sq ft • PERIMETER: 65' 1 1/2"

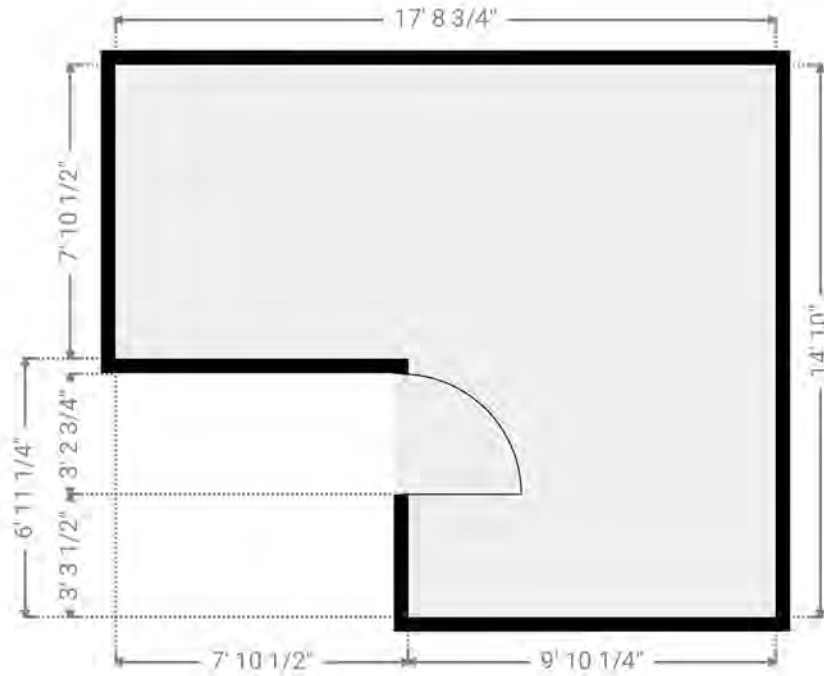

## ▼ Other Ground Floor

WIDTH: 13' 7" • LENGTH: 9' 6 1/2" • CEILING HEIGHT: 9' 8"  
AREA: 129.72 sq ft • PERIMETER: 46' 3 1/4"

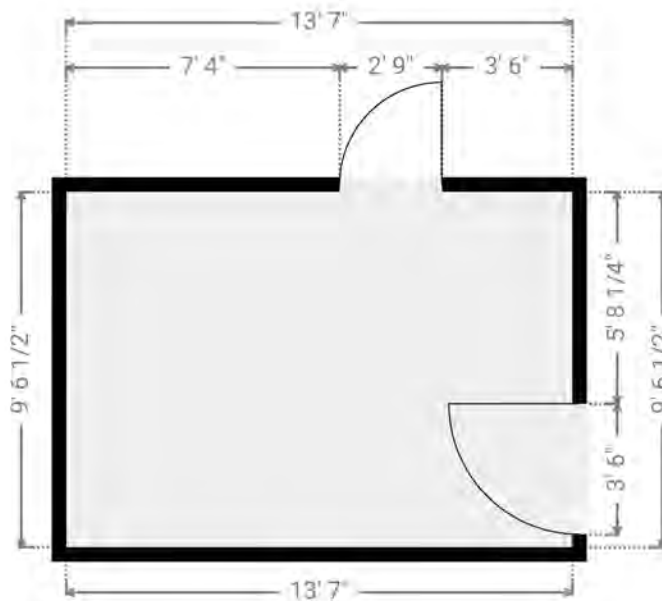

THIS FLOOR PLAN IS PROVIDED WITHOUT WARRANTY OF ANY KIND. SENSOPIA DISCLAIMS ANY WARRANTY INCLUDING, WITHOUT LIMITATION, SATISFACTORY QUALITY OR ACCURACY OF DIMENSIONS.



# Yoast Candy Co Inc

51 S Cochran St, 44618 Dalton, OH, United States

TOTAL AREA: 24366.23 sq ft · LIVING AREA: 24085.83 sq ft · FLOORS: 1 · ROOMS: 22



## ▼ Other Ground Floor

WIDTH: 10' 3" · LENGTH: 4' 1" · CEILING HEIGHT: 7' 3/4"  
AREA: 41.89 sq ft · PERIMETER: 28' 8"

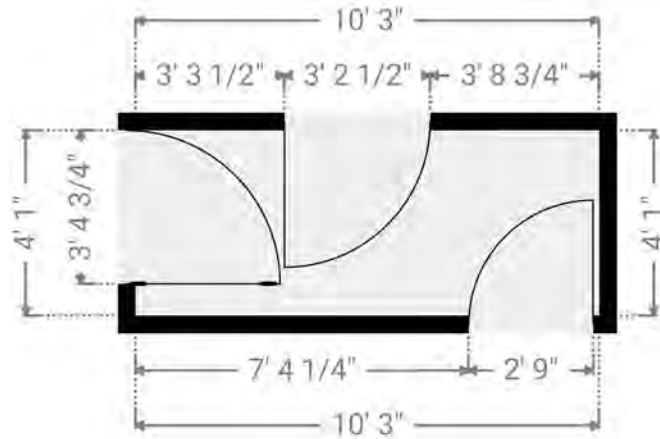

## ▼ Other Ground Floor

WIDTH: 13' 6 3/4" · LENGTH: 11' 2 1/4" · CEILING HEIGHT: 7' 5 3/4"  
AREA: 118.03 sq ft · PERIMETER: 49' 6"

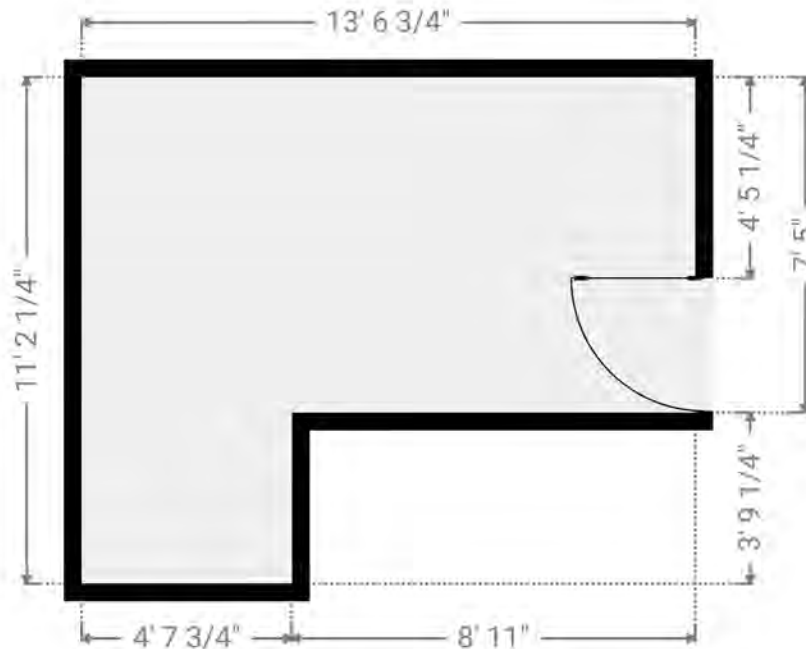

THIS FLOOR PLAN IS PROVIDED WITHOUT WARRANTY OF ANY KIND. SENSOPIA DISCLAIMS ANY WARRANTY INCLUDING, WITHOUT LIMITATION, SATISFACTORY QUALITY OR ACCURACY OF DIMENSIONS.

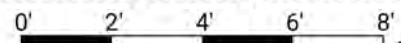

# Yoast Candy Co Inc

51 S Cochran St, 44618 Dalton, OH, United States

TOTAL AREA: 24366.23 sq ft • LIVING AREA: 24085.83 sq ft • FLOORS: 1 • ROOMS: 22



## ▼ Other Ground Floor

WIDTH: 8' 6 1/2" • LENGTH: 10' 1/2" • CEILING HEIGHT: 8' 3"  
AREA: 85.76 sq ft • PERIMETER: 37' 2"

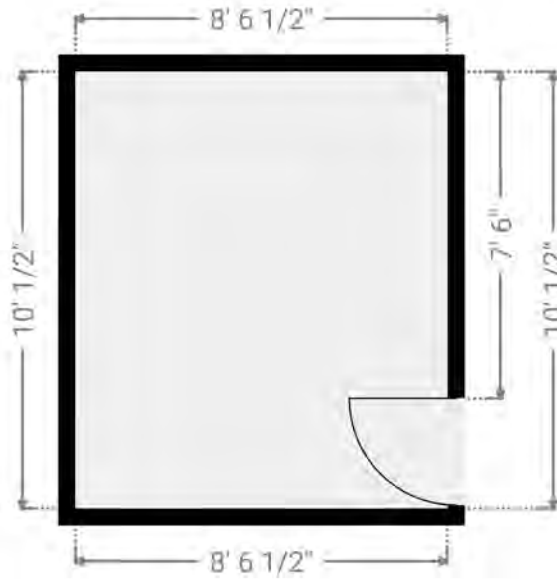

## ▼ Other Ground Floor

WIDTH: 13' 7 1/2" • LENGTH: 11' 11 3/4" • CEILING HEIGHT: 8' 7"  
AREA: 103.65 sq ft • PERIMETER: 51' 2 1/4"

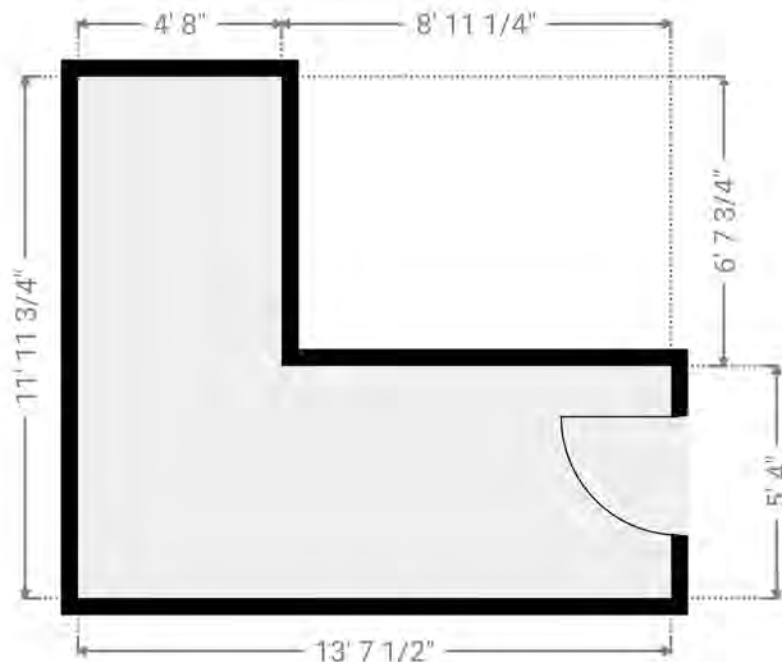

THIS FLOOR PLAN IS PROVIDED WITHOUT WARRANTY OF ANY KIND. SENSOPIA DISCLAIMS ANY WARRANTY INCLUDING, WITHOUT LIMITATION, SATISFACTORY QUALITY OR ACCURACY OF DIMENSIONS.

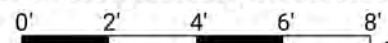

# Yoast Candy Co Inc

51 S Cochran St, 44618 Dalton, OH, United States

TOTAL AREA: 24366.23 sq ft • LIVING AREA: 24085.83 sq ft • FLOORS: 1 • ROOMS: 22



## ▼ Other Ground Floor

WIDTH: 13' 8" • LENGTH: 6' 8 1/2" • CEILING HEIGHT: 6' 9 3/4"  
AREA: 91.73 sq ft • PERIMETER: 40' 9"

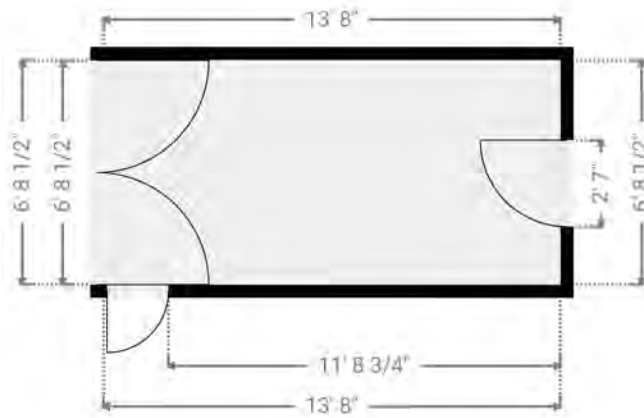

## ▼ Other Ground Floor

WIDTH: 13' 8 3/4" • LENGTH: 12' 8 1/4" • CEILING HEIGHT: 5' 1 1/2"  
AREA: 174.03 sq ft • PERIMETER: 52' 9 3/4"

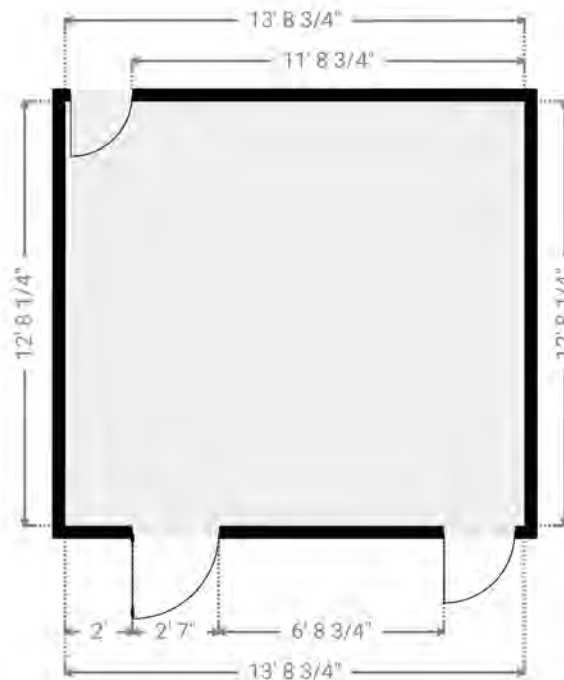

THIS FLOOR PLAN IS PROVIDED WITHOUT WARRANTY OF ANY KIND. SENSOPIA DISCLAIMS ANY WARRANTY INCLUDING, WITHOUT LIMITATION, SATISFACTORY QUALITY OR ACCURACY OF DIMENSIONS.



# Yoast Candy Co Inc

51 S Cochran St, 44618 Dalton, OH, United States

TOTAL AREA: 24366.23 sq ft • LIVING AREA: 24085.83 sq ft • FLOORS: 1 • ROOMS: 22



## ▼ Other Ground Floor

WIDTH: 6' 8" • LENGTH: 6' 4 1/4" • CEILING HEIGHT: 7' 7 1/2"  
AREA: 42.27 sq ft • PERIMETER: 26' 1/4"

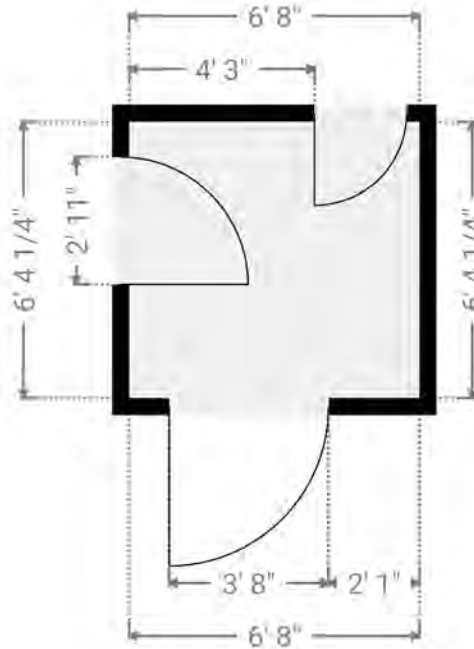

## ▼ Other Ground Floor

WIDTH: 6' 8" • LENGTH: 8' 6 3/4" • CEILING HEIGHT: 7' 11 1/2"  
AREA: 57.12 sq ft • PERIMETER: 30' 5 3/4"

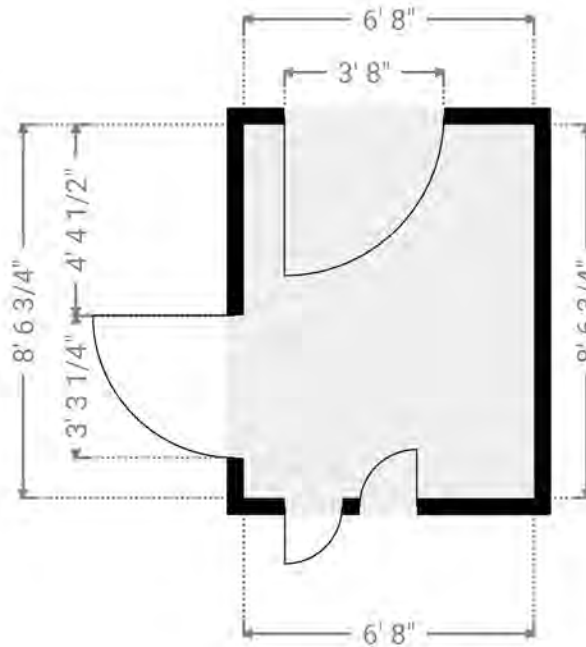

THIS FLOOR PLAN IS PROVIDED WITHOUT WARRANTY OF ANY KIND. SENSOPIA DISCLAIMS ANY WARRANTY INCLUDING, WITHOUT LIMITATION, SATISFACTORY QUALITY OR ACCURACY OF DIMENSIONS.

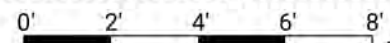



# Yoast Candy Co Inc

51 S Cochran St, 44618 Dalton, OH, United States

TOTAL AREA: 24366.23 sq ft · LIVING AREA: 24085.83 sq ft · FLOORS: 1 · ROOMS: 22



## ▼ Other Ground Floor

WIDTH: 6' 7 3/4" · LENGTH: 14' 3/4" · CEILING HEIGHT: 8' 7 3/4"  
AREA: 93.51 sq ft · PERIMETER: 41' 5"

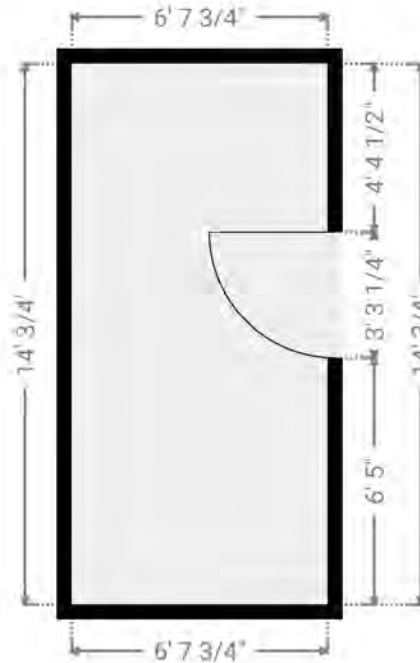

## ▼ Other Ground Floor

WIDTH: 6' 9 1/4" · LENGTH: 5' 3/4" · CEILING HEIGHT: 7' 7"  
AREA: 34.15 sq ft · PERIMETER: 23' 8"

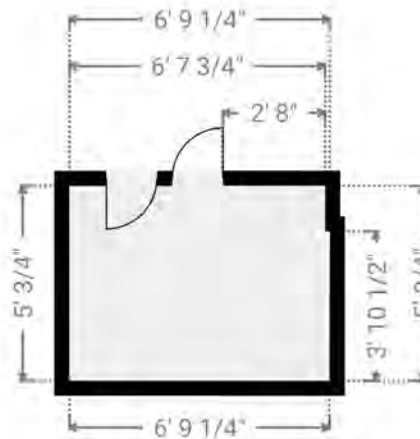

THIS FLOOR PLAN IS PROVIDED WITHOUT WARRANTY OF ANY KIND. SENSOPIA DISCLAIMS ANY WARRANTY INCLUDING, WITHOUT LIMITATION, SATISFACTORY QUALITY OR ACCURACY OF DIMENSIONS.



# Yoast Candy Co Inc

51 S Cochran St, 44618 Dalton, OH, United States

TOTAL AREA: 24366.23 sq ft • LIVING AREA: 24085.83 sq ft • FLOORS: 1 • ROOMS: 22



## ▼ Other Ground Floor

WIDTH: 6' 8 1/2" • LENGTH: 6' 4 1/4" • CEILING HEIGHT: 7' 7"  
AREA: 42.59 sq ft • PERIMETER: 26' 1 1/4"

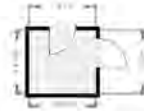

## ▼ Other Ground Floor

WIDTH: 64' 8" • LENGTH: 62' 1 1/2" • CEILING HEIGHT: 15' 7 3/4"  
AREA: 3436.13 sq ft • PERIMETER: 253' 4 3/4"

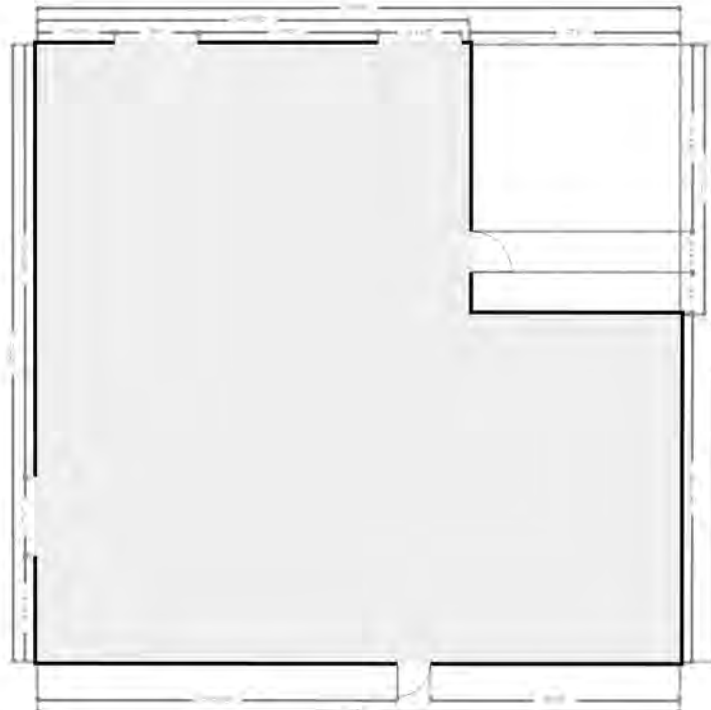

THIS FLOOR PLAN IS PROVIDED WITHOUT WARRANTY OF ANY KIND. SENSOPIA DISCLAIMS ANY WARRANTY INCLUDING, WITHOUT LIMITATION, SATISFACTORY QUALITY OR ACCURACY OF DIMENSIONS.

0' 8' 16' 24' 32' 1:232

# Yoast Candy Co Inc

51 S Cochran St, 44618 Dalton, OH, United States

TOTAL AREA: 24366.23 sq ft • LIVING AREA: 24085.83 sq ft • FLOORS: 1 • ROOMS: 22



## ▼ Other Ground Floor

WIDTH: 58' 3/4" • LENGTH: 60' 10 1/4" • CEILING HEIGHT: 13' 11"  
AREA: 3529.45 sq ft • PERIMETER: 237' 8 1/2"

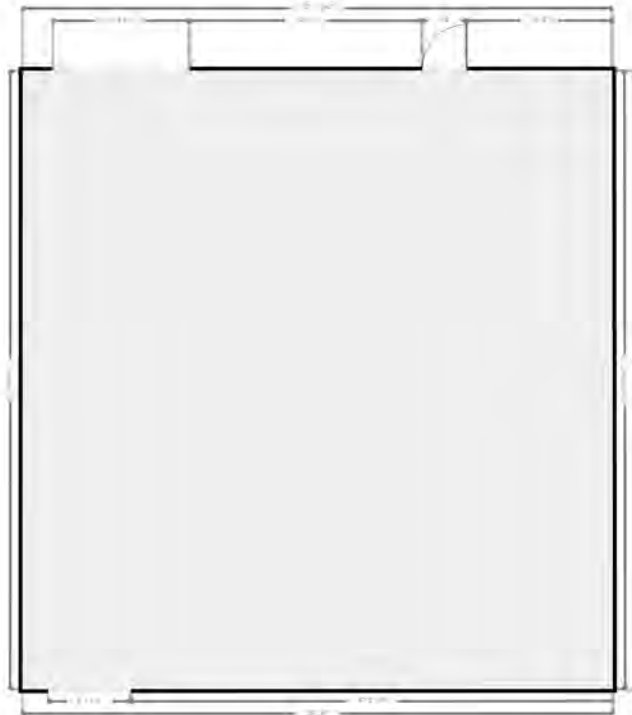

## ▼ Other Ground Floor

WIDTH: 57' 11 3/4" • LENGTH: 17' 2 1/2" • CEILING HEIGHT: 12' 6"  
AREA: 997.69 sq ft • PERIMETER: 150' 4 1/2"



# Yoast Candy Co Inc

51 S Cochran St, 44618 Dalton, OH, United States

TOTAL AREA: 24366.23 sq ft • LIVING AREA: 24085.83 sq ft • FLOORS: 1 • ROOMS: 22



## ▼ Other Ground Floor

WIDTH: 28' 10 3/4" • LENGTH: 23' 2 3/4" • CEILING HEIGHT: 7' 4 1/2"  
AREA: 670.91 sq ft • PERIMETER: 104' 2 3/4"

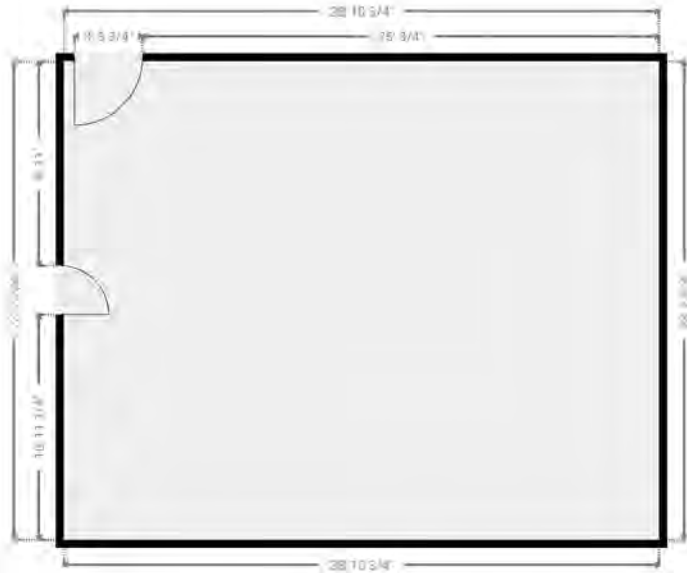

## ▼ Other Ground Floor

WIDTH: 20' 10" • LENGTH: 26' 9 1/4" • CEILING HEIGHT: 27' 10 1/4"  
AREA: 557.89 sq ft • PERIMETER: 95' 2 3/4"

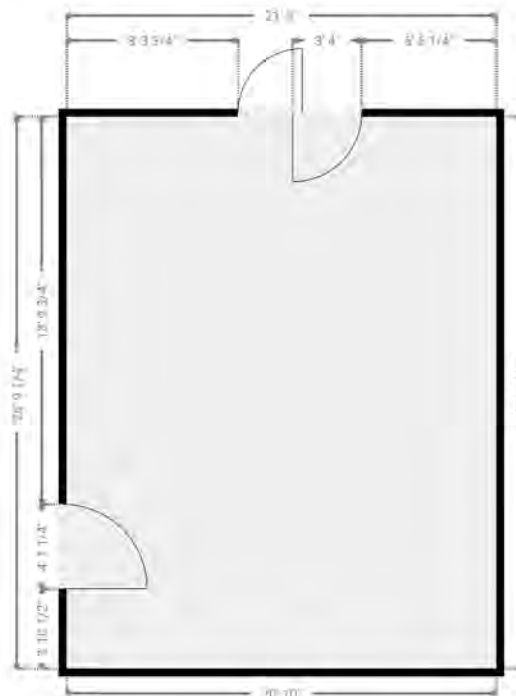

THIS FLOOR PLAN IS PROVIDED WITHOUT WARRANTY OF ANY KIND. SENSOPIA DISCLAIMS ANY WARRANTY INCLUDING, WITHOUT LIMITATION, SATISFACTORY QUALITY OR ACCURACY OF DIMENSIONS.

